

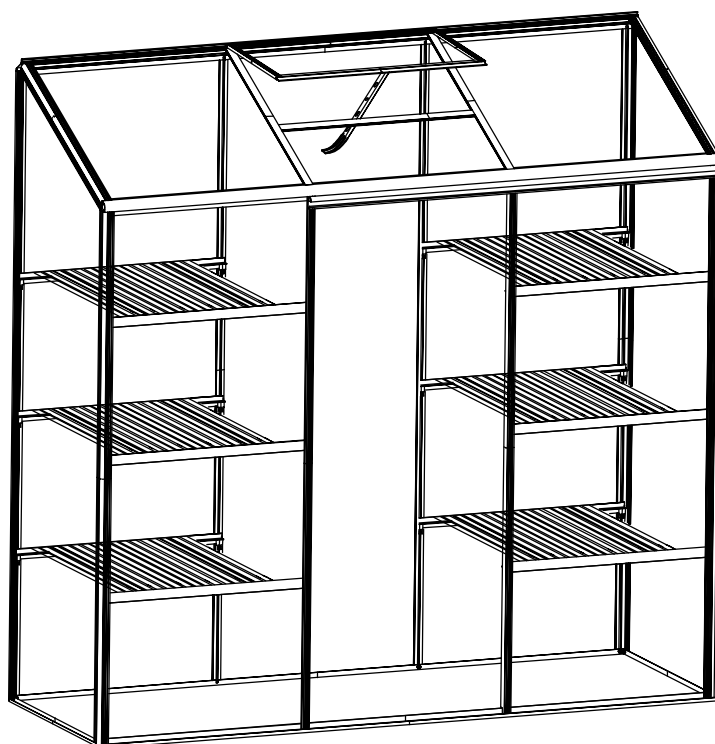

Hobbyväxthus Sverige AB

MANUAL: MARION-33G



MODELL: MARION-33G



STORLEK (BxLxH): 60x190x187CM

LÄS MANUALEN INNAN MONTERING



Sid.3 Dörr

| Del | Nr. | Ant. |
|--|------|------|
|  | L15 | 1 |
|  | L17 | 1 |
|  | L18A | 2 |





Sid.4 Vädringslucka

| Del | Nr. | Ant. |
|--|-----|------|
|  | L19 | 2 |
|  | L20 | 1 |
|  | L21 | 1 |







Sid.5 Hyllor

| Del | Nr. | Ant. |
|--|------|------|
|  | L02A | 30 |
|  | L09 | 12 |





Sid.6-7 Baksida

| Del | Nr. | Ant. |
|--|------|------|
|  | L01A | 1 |
|  | L01B | 1 |
|  | L03A | 2 |
|  | L06 | 1 |
|  | L08A | 1 |









Sid.8-10 Framsida

| Del | Nr. | Ant. |
|---|------|------|
|  | L01C | 1 |
|  | L01D | 1 |
|  | L04A | 1 |
|  | L04B | 1 |
|  | L07 | 1 |
|  | L10 | 1 |
|  | L14 | 1 |













Sid.11-15 Slutmontering



| Del | Nr. | Ant. |
|---|------|------|
|  | L01E | 1 |
|  | L01F | 1 |
|  | L03B | 1 |
|  | L03C | 2 |
|  | L08B | 2 |

Kanalplast



| Del | Nr. | Ant. |
|---|-----|------|
|  | Y1 | 1 |
|  | Y2 | 3 |
|  | Y3 | 2 |
|  | Y4 | 1 |
|  | Y5 | 2 |
|  | Y6 | 1 |
|  | Y7 | 1 |
|  | Y8 | 1 |

DELAR

| Del | Nr. | Ant. |
|---|--------|------|
|  | W01 | 24 |
|  | S01 | 116 |
| | M6X10 | |
|  | M01 | 118 |
| | M6 | |
|  | S02 | 2 |
| | M6X16 | |
|  | Z01 | 8 |
| | Ø4X16 | |
|  | Z02 | 5 |
| | Ø4X16D | |
|  | Z03 | 5 |
| | Ø4X10 | |
|  | J01 | 2 |
|  | J03L/R | 1/1 |
|  | W06 | 1 |
|  | W08 | 1 |
|  | W04 | 2 |

| | | |
|---|-------|---|
|  | J05 | 4 |
|  | Z01 | 4 |
| | Ø4X16 | |

Sid.3 Dörr

| Del | Nr. | Ant. |
|--|------|------|
|  | L15 | 1 |
|  | L17 | 1 |
|  | L18A | 2 |

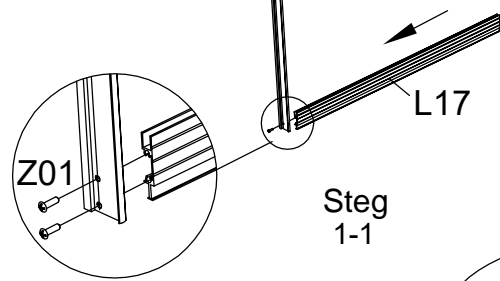
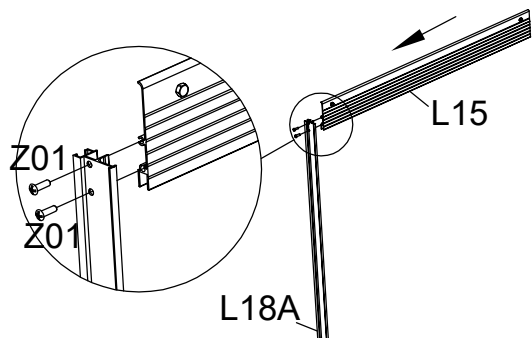

Mycket viktigt!
Den sida på kanalplasten som har vit skyddsfilm skall monteras utåt, d.v.s. mot solen.

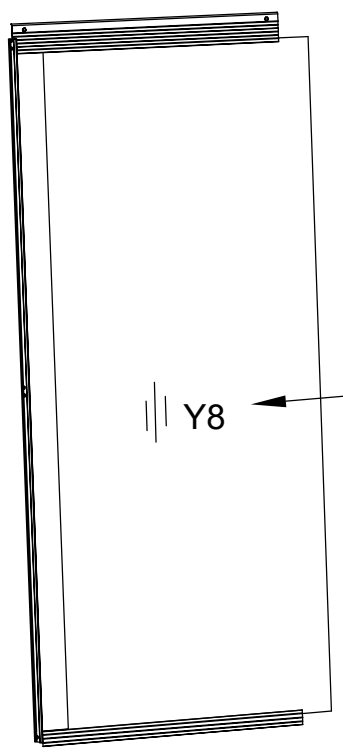



Steg 1-2



Tips!
Om spetsen på de självgående skruvarna doppas i diskmedel blir de mycket enklare att skruva i.

Steg 1-3

| Del | Nr. | Ant. |
|--|-----|------|
|  | L19 | 2 |
|  | L20 | 1 |
|  | L21 | 1 |

Sid.4 Vadringslucka



Mycket viktigt!

Den sida pa kanalplasten som har vit skyddsfilm skall monteras utåt, d.v.s. mot solen.

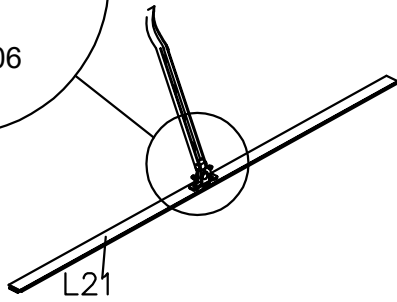
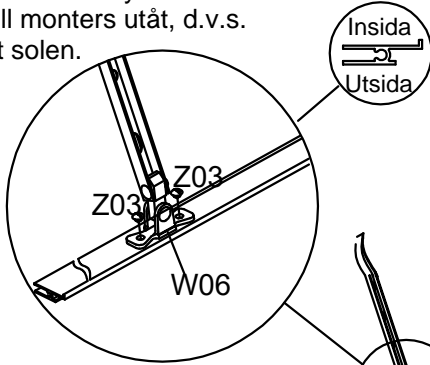

Steg 2-1

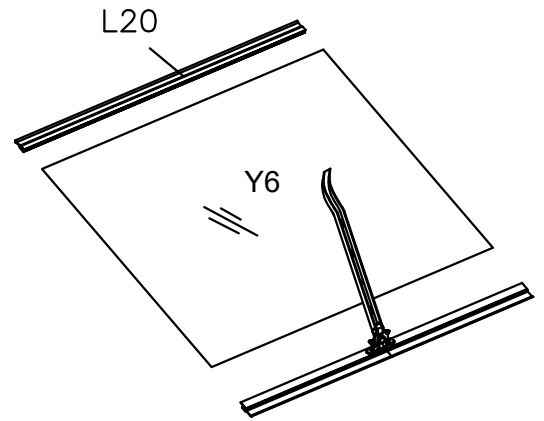

Steg 2-2

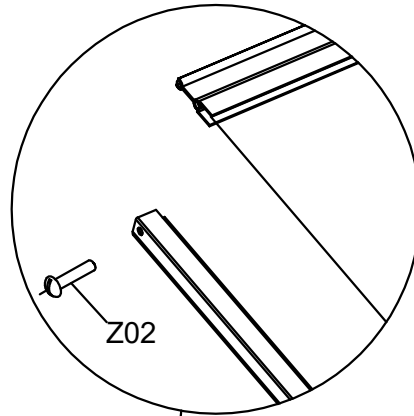

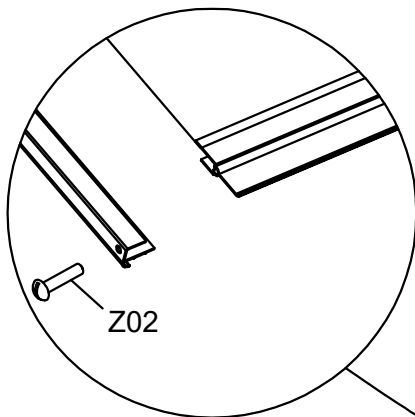

Tips!

Om spetsen pa de sjalvgangande skruvarna doppas i diskmedel blir de mycket enklare att skruva i.





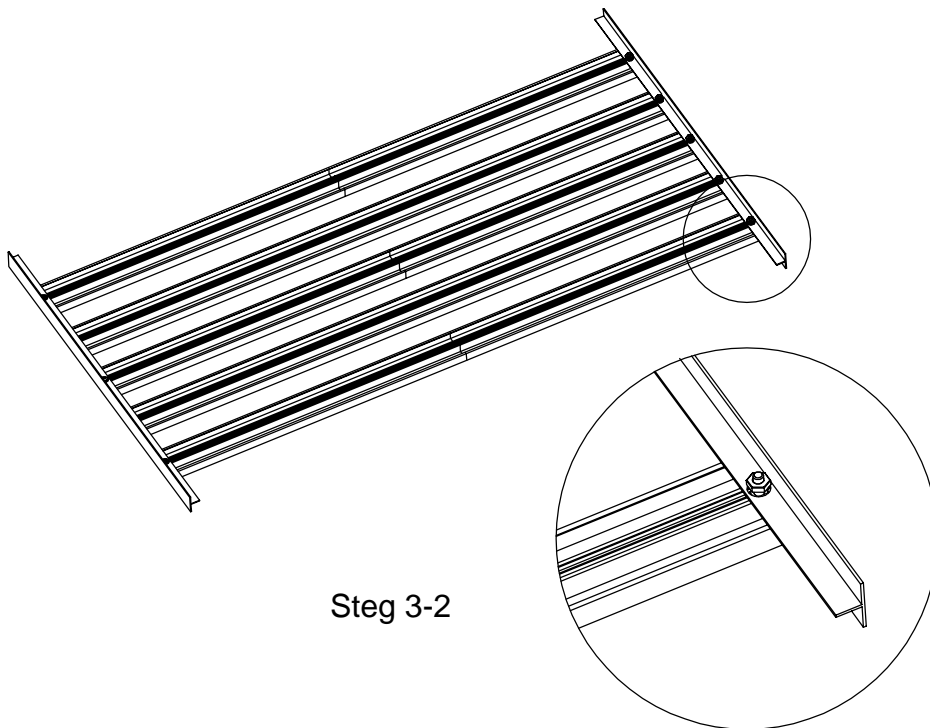
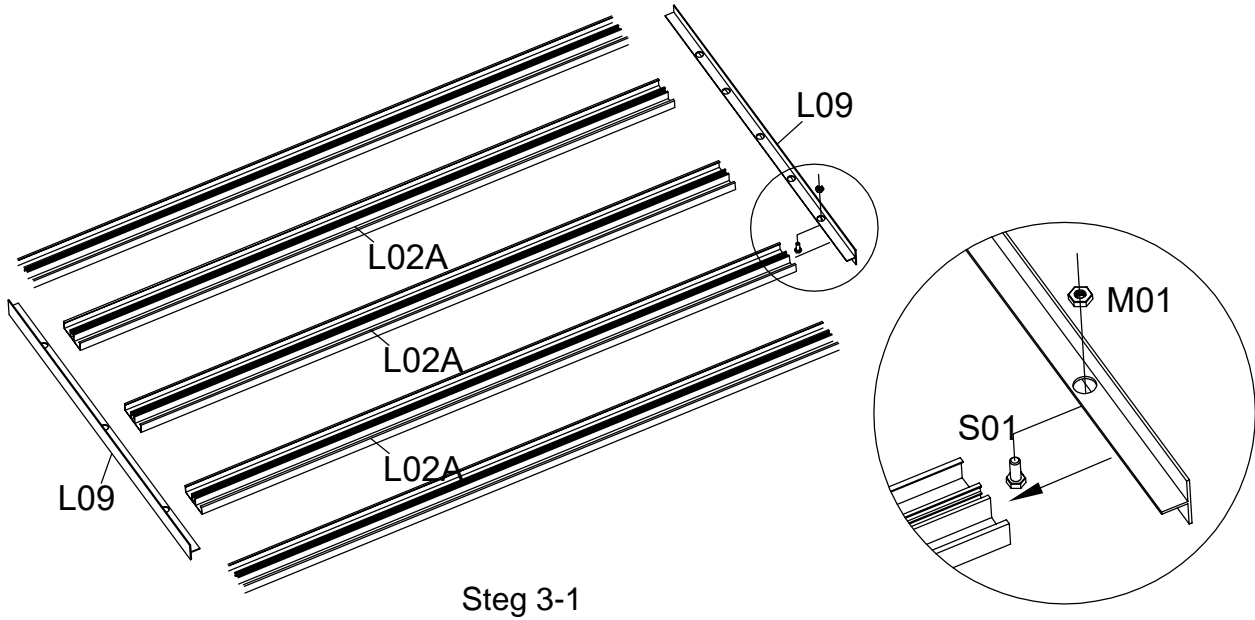

Steg 2-3

| Del | Nr. | Ant. |
|--|------|------|
|  | L02A | 30 |
|  | L09 | 12 |

Sid.5 Hyllor



Sid.6-7 Baksida

| Del | Nr. | Ant. |
|--|------|------|
|  | L01A | 1 |
|  | L01B | 1 |
|  | L03A | 2 |
|  | L06 | 1 |
|  | L08A | 1 |

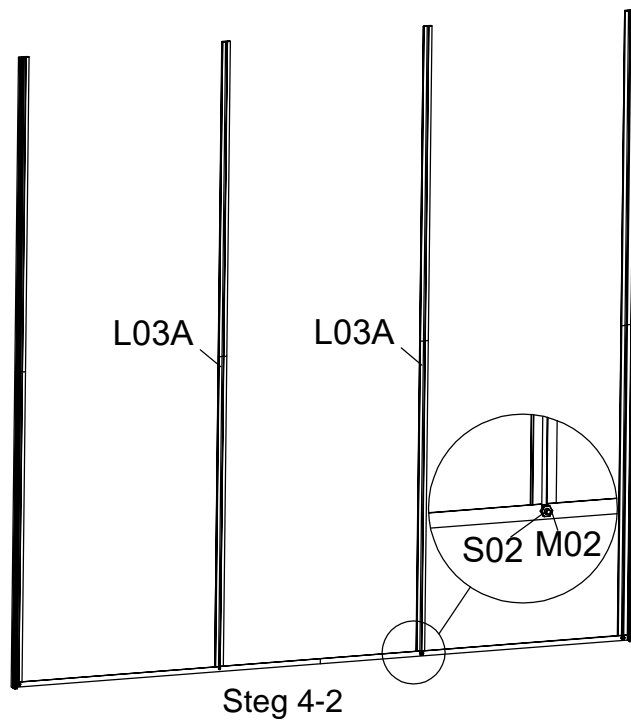
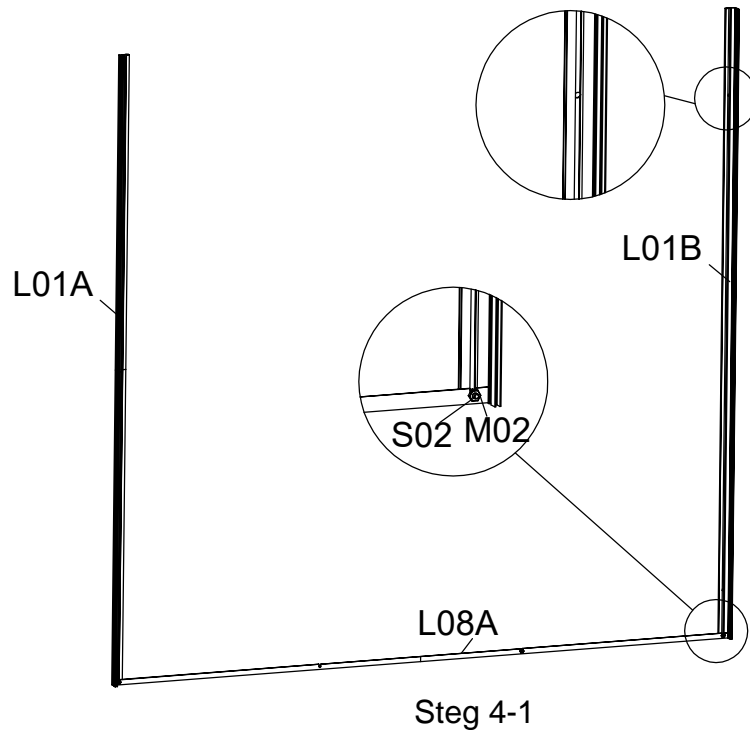

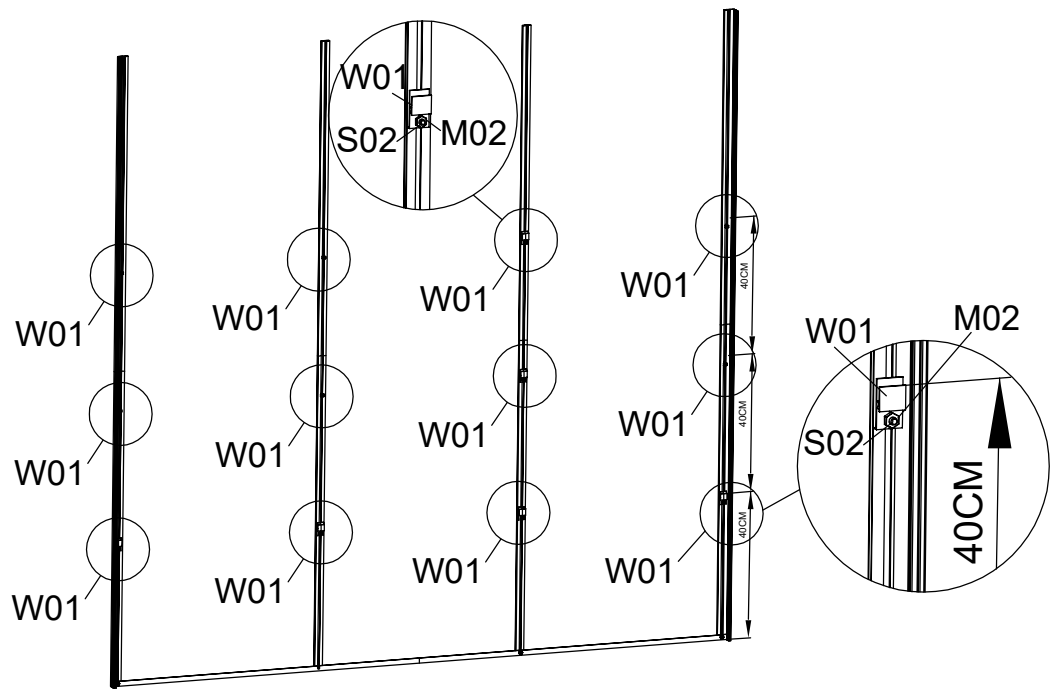

Steg 4-3



Mycket viktigt!
Den sida på kanalplasten
som har vit skyddsfilm
skall monteras utåt, d.v.s.
mot solen.

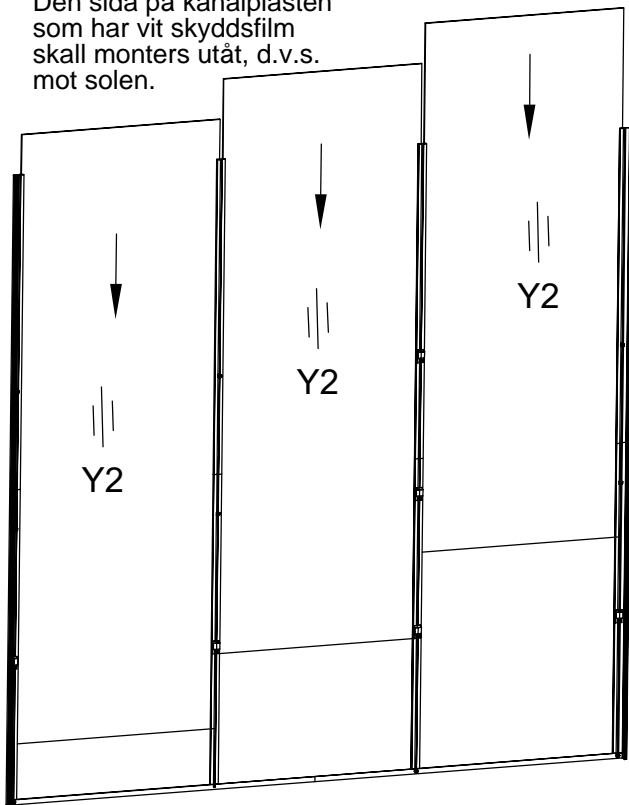



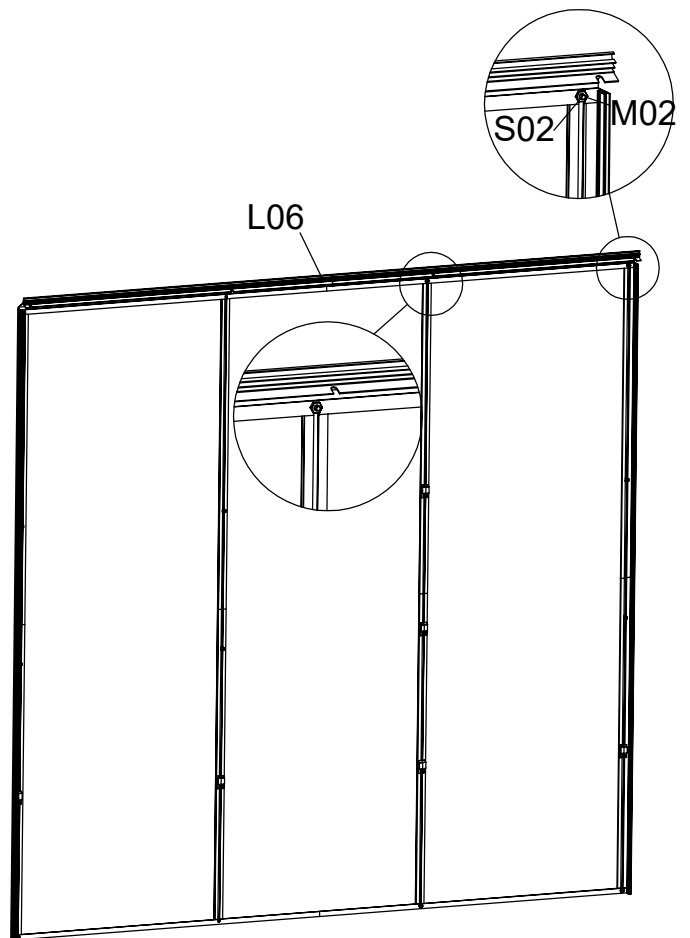



Steg 4-4



Steg 4-5

Sid.8-10 Framsida

| Del | Nr. | Ant. |
|--|------|------|
|  | L01C | 1 |
|  | L01D | 1 |
|  | L04A | 1 |
|  | L04B | 1 |
|  | L07 | 1 |
|  | L10 | 1 |
|  | L14 | 1 |

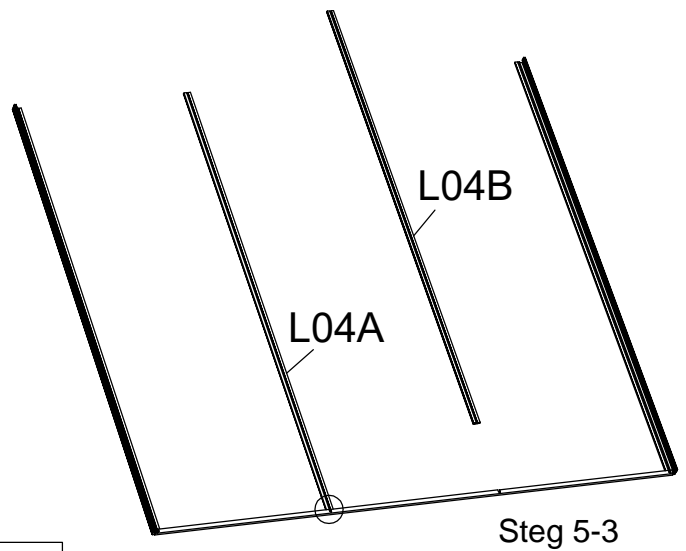
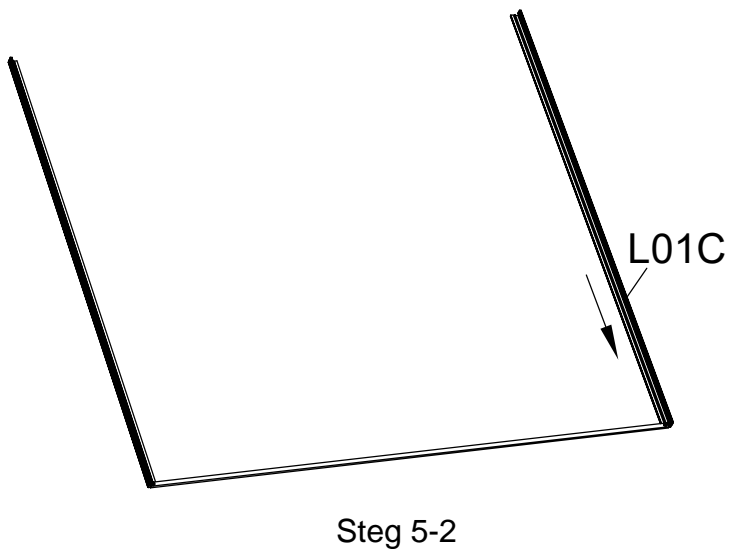
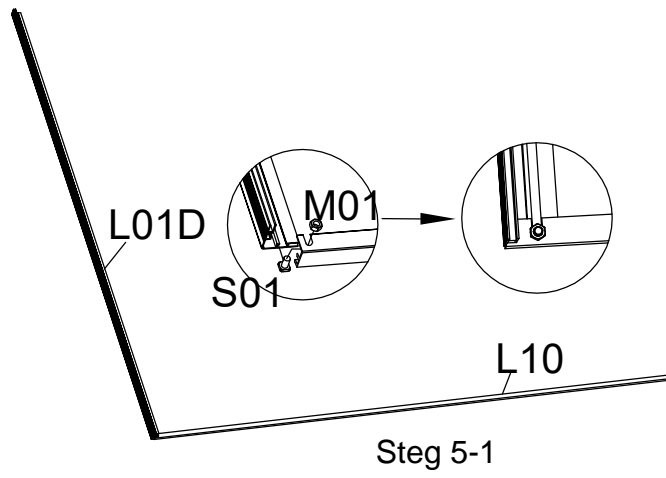

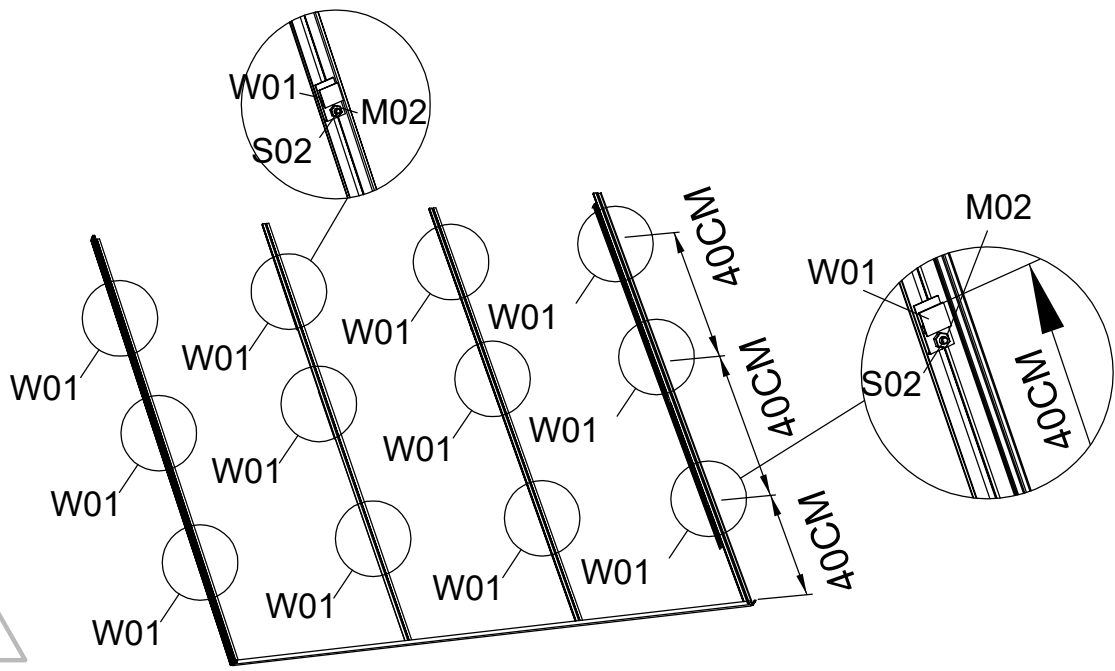

Mycket viktigt!
 Den sida på kanalplasten
 som har vit skyddsfilm
 skall monteras utåt, d.v.s.
 mot solen.

Steg 5-4

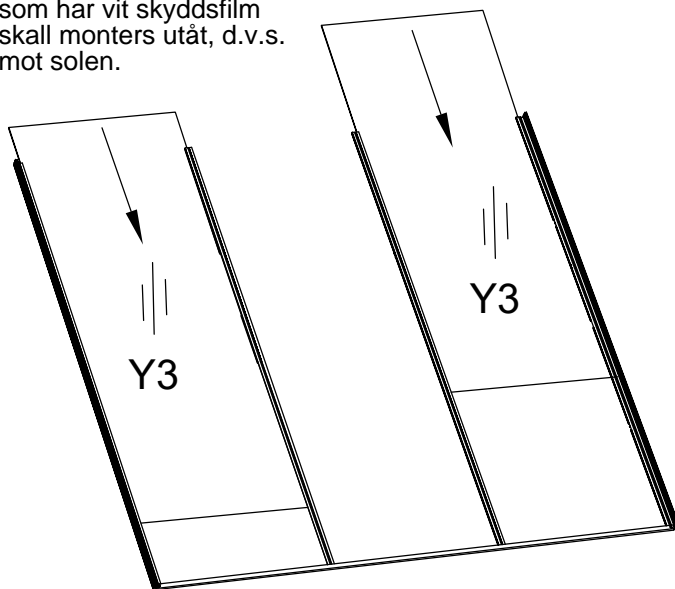

Steg 5-5

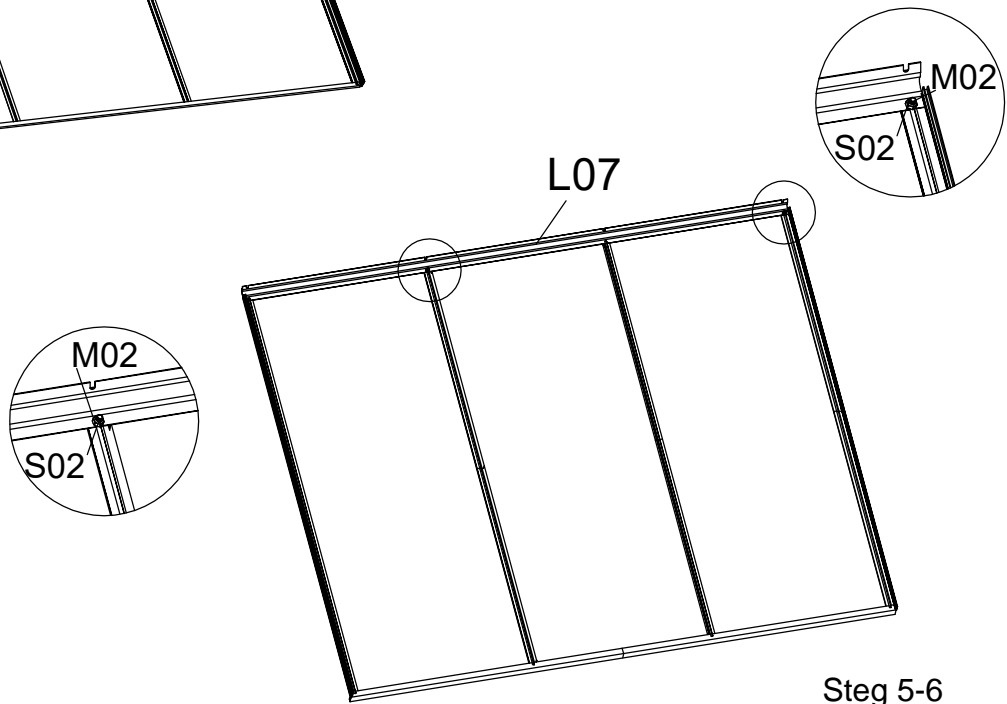

Steg 5-6

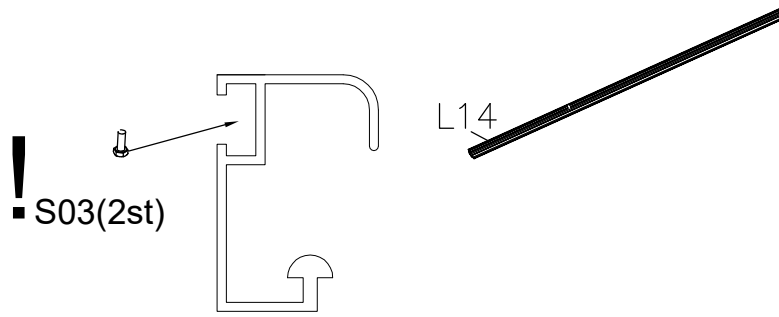



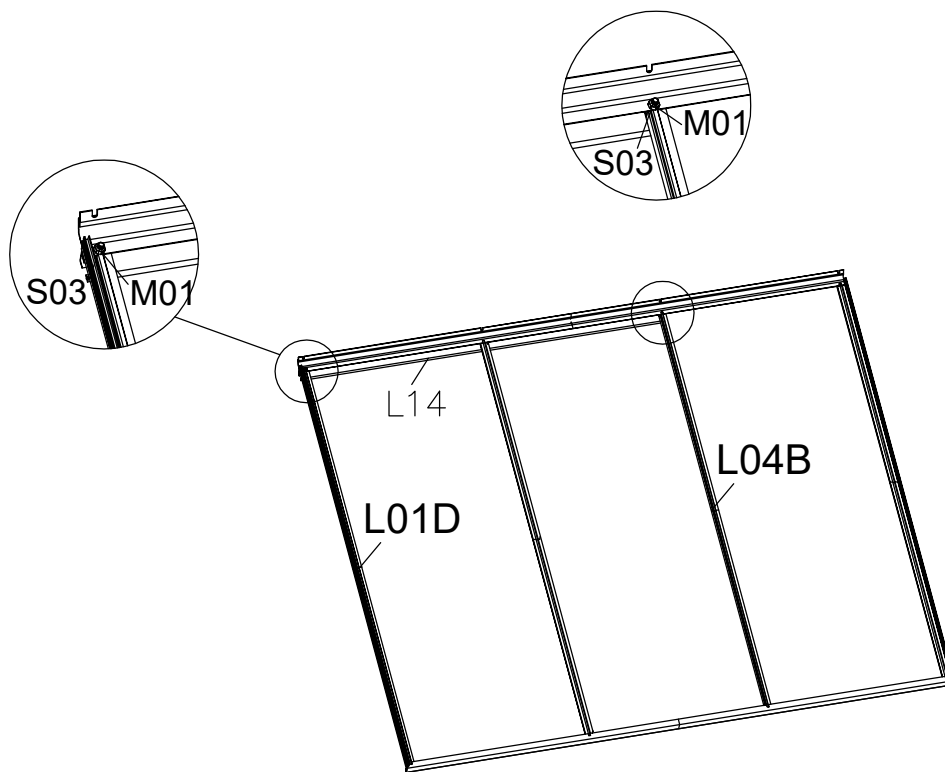

Steg 5-7



Steg 5-8

Sid.11-15 Slutmontering

| Del | Nr. | Ant. |
|--|------|------|
|  | L01E | 1 |
|  | L01F | 1 |
|  | L03B | 1 |
|  | L03C | 2 |
|  | L08B | 2 |

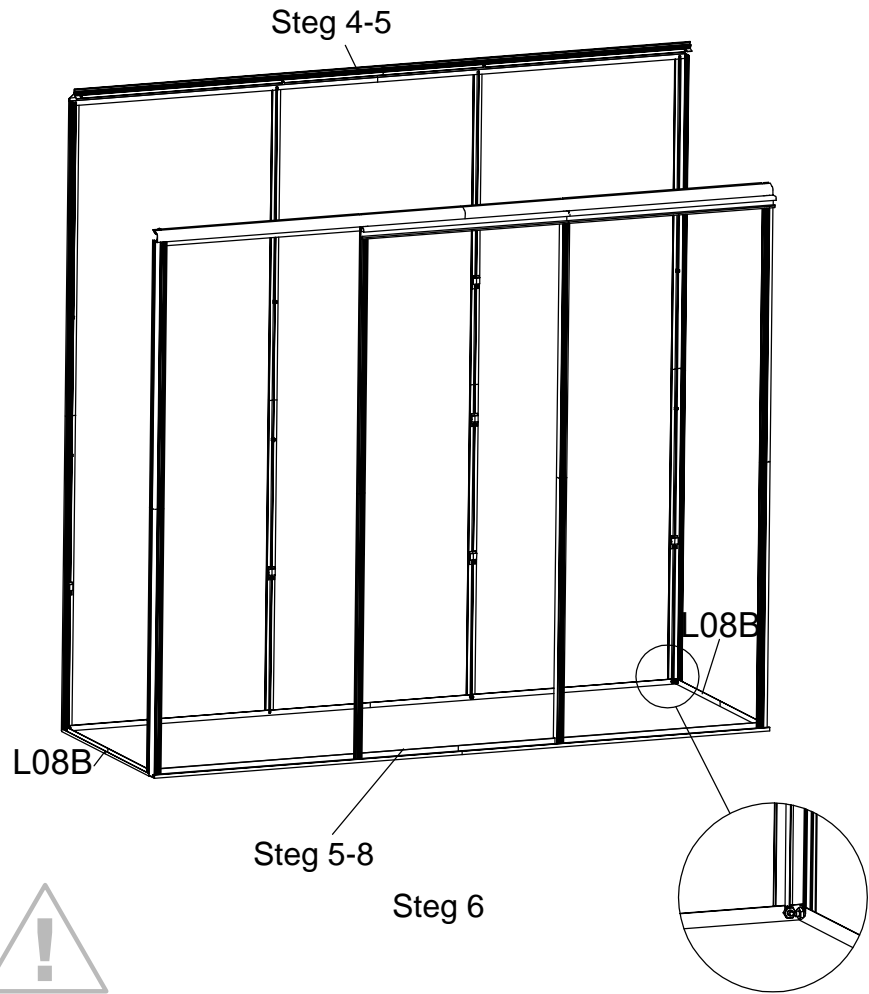

Mycket viktigt!
Den sida på kanalplasten
som har vit skyddsfilm
skall monteras utåt, d.v.s.
mot solen.

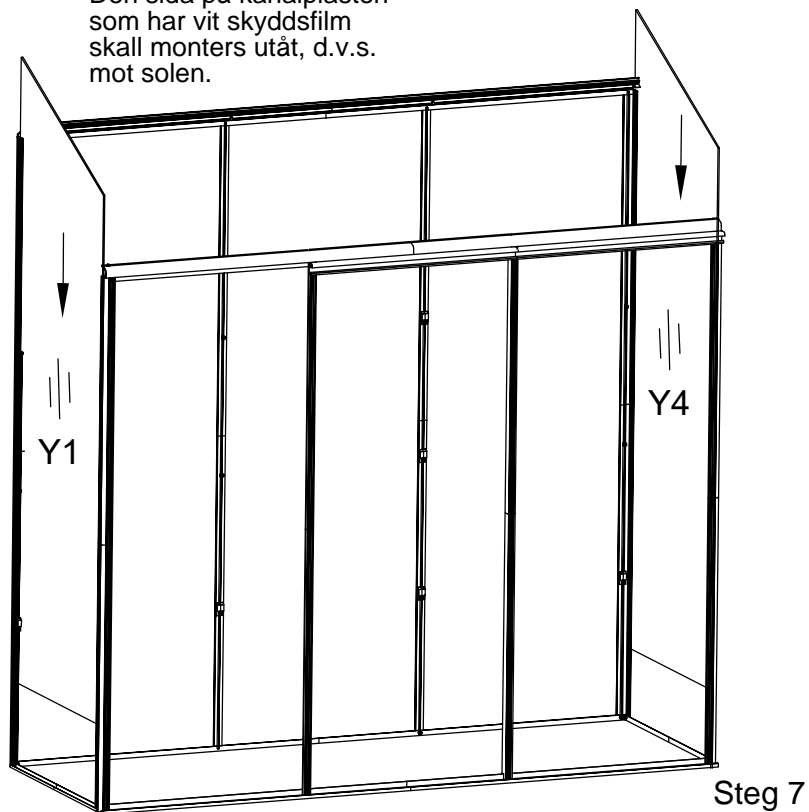

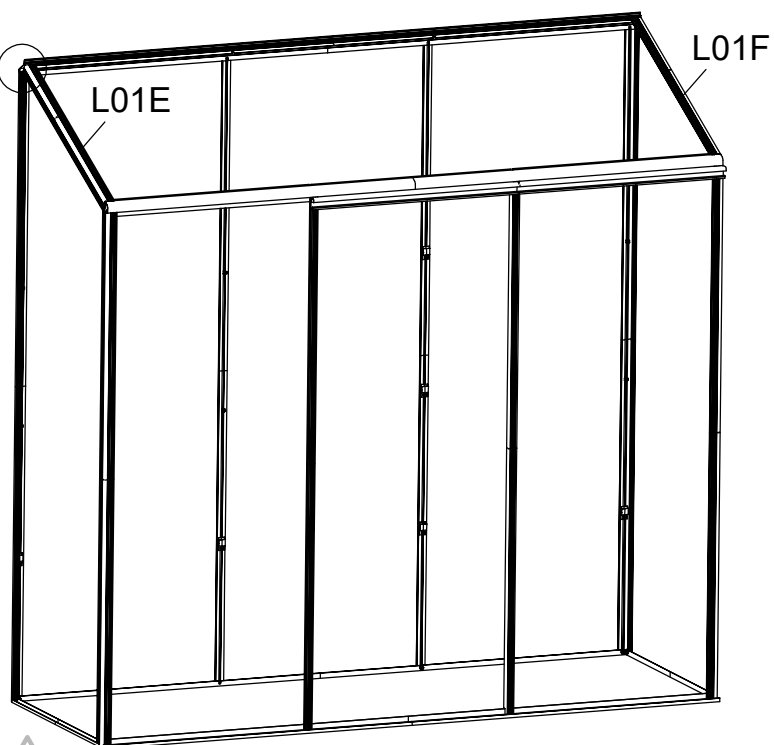
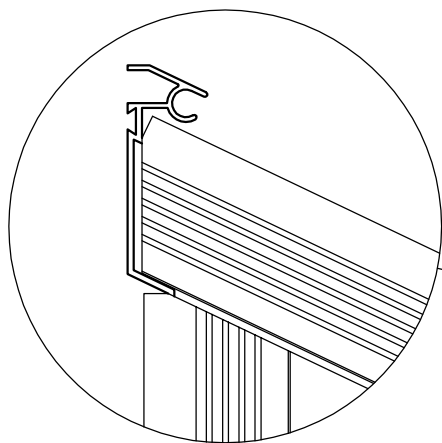

Steg 8



Mycket viktigt!
Den sida på kanalplasten
som har vit skyddsfilm
skall monteras utåt, d.v.s.
mot solen.

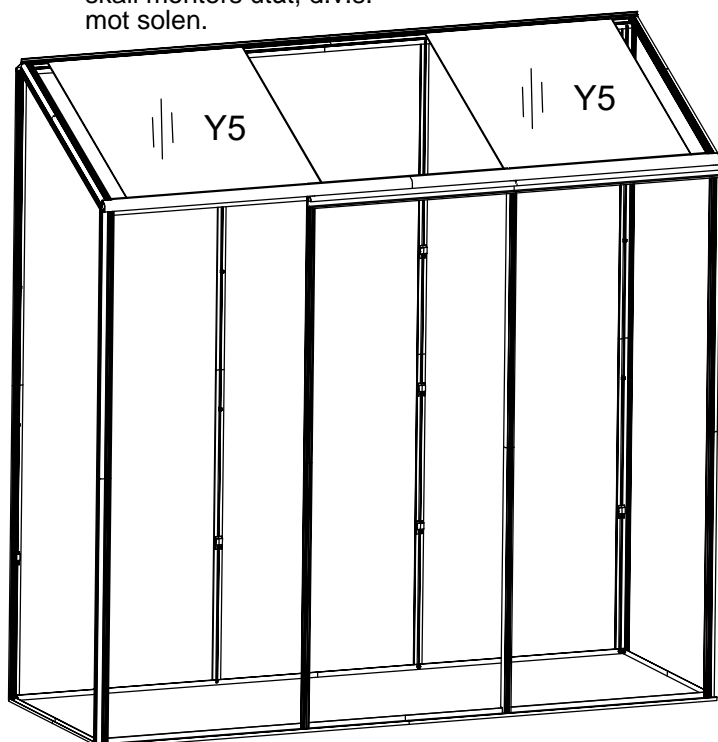

Steg 9

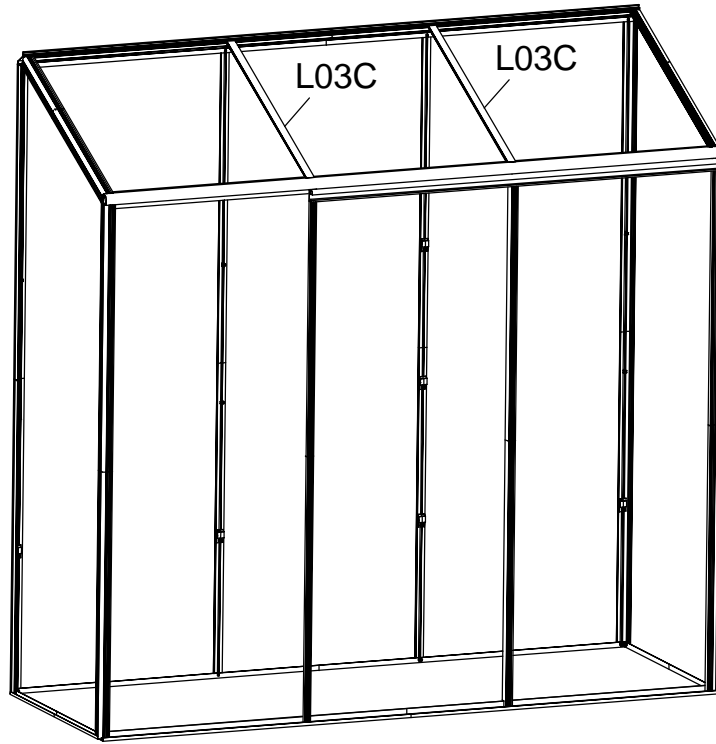

Step 10

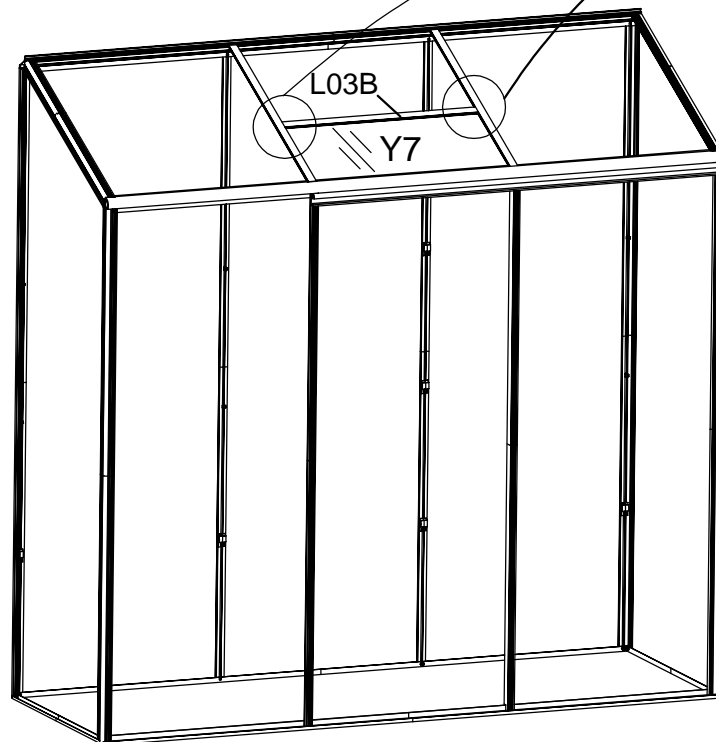
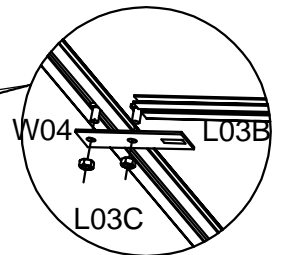
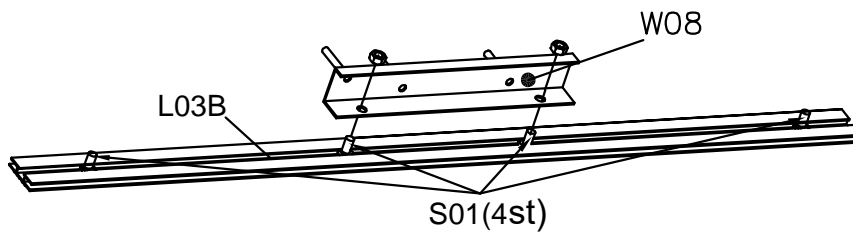

Step 11

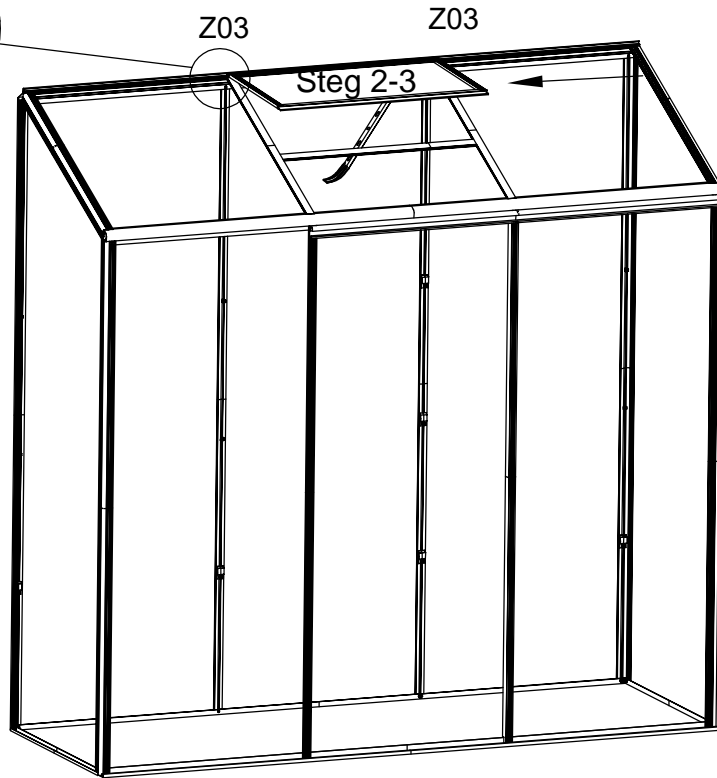
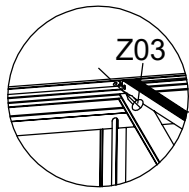

Step 12

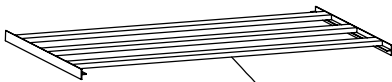

Steg 3-2

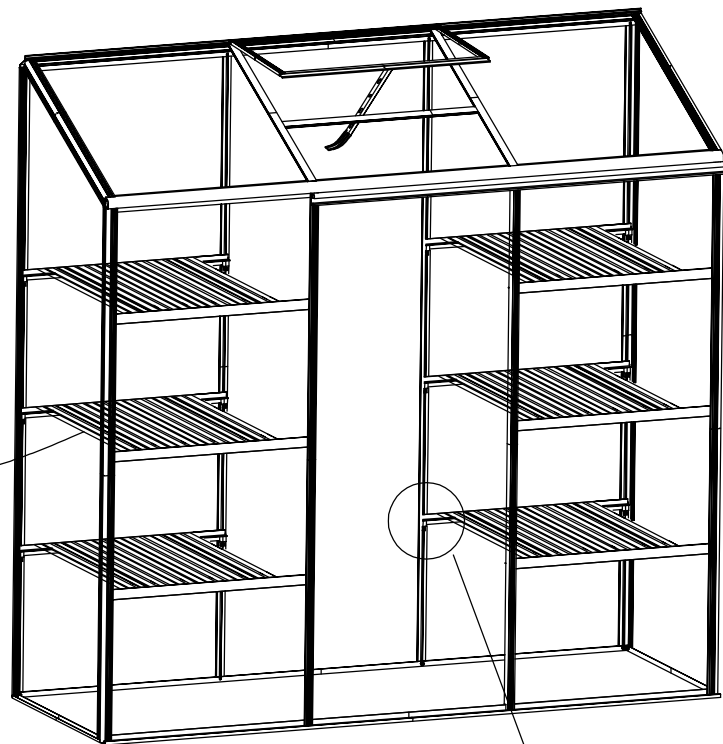

Step 13

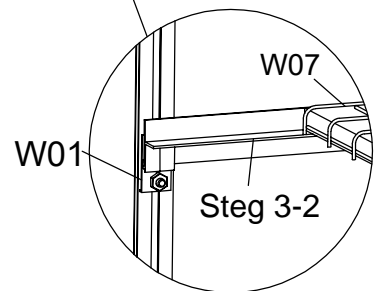

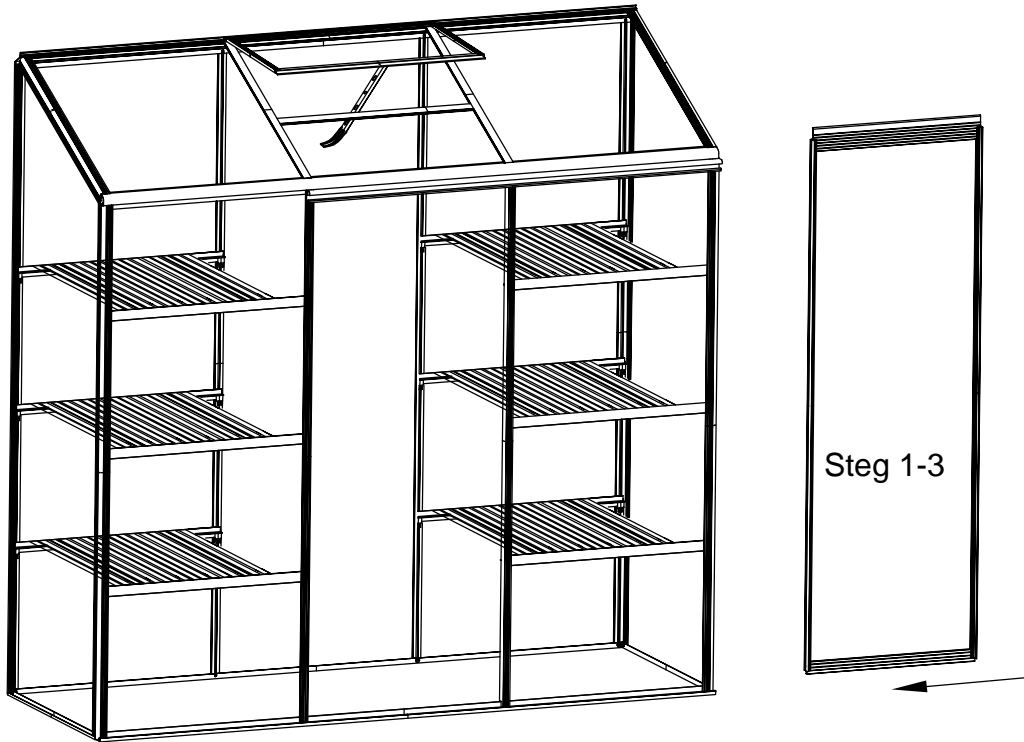

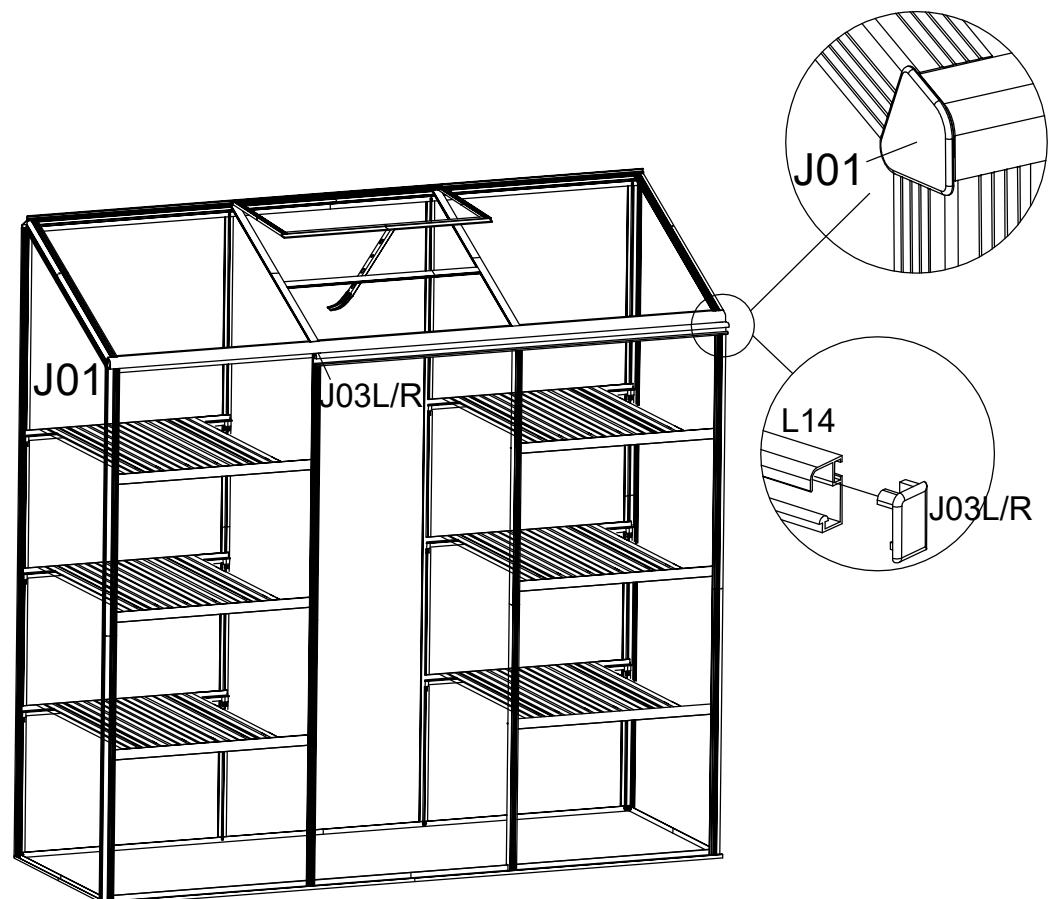

Steg 14



Steg 15

| Del | Nr. | Ant. |
|--|-----|------|
|  | J05 | 4 |
|  | Z01 | 4 |

